

LIMITS	MARK	REVISE	DATE	REVISER
	△1			
1 _N 4±0.10	△2			
4 _N 16±0.15	△3			
16 _N 64±0.20	△4			
64 _N 250±0.30	△5			
250 _N 1000±0.40	△6			

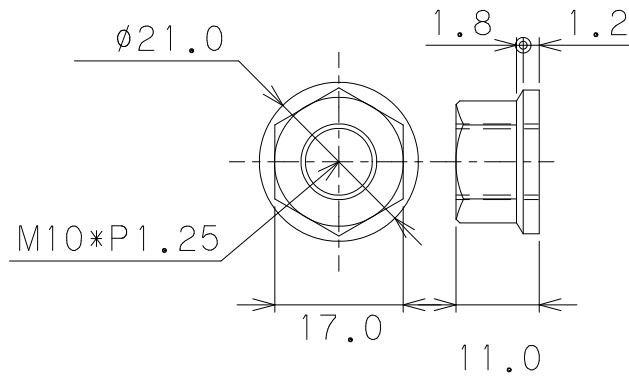

DATE 15/04/01		CORD	TITLE M10*P1.25 ナット
PROJECTION METHOD 	SCALE	MATERIAL	REMARK
		WEIGHT	DRAWING.NO.
APPROVED	DRAWN	MODEL	△ one for all ofa co.,LTD. <i>ofa</i>